

CIRCUMFERENTIAL PISTON PUMP



TRA10SERIES



wright flow
TECHNOLOGIES[®]

Capacity to 102 m³/hr / 450 USGPM

Pressure to 27 Bar / 400 PSI

Viscosity to 200,000 cSt / 910,000 SSU

Temperature to 150°C / to 300°F

HYGIENIC PUMP SOLUTIONS

IDEX
FLUID & METERING

YOUR COMPLETE

Hygienic Solutions Provider

- GLOBAL PRESENCE WITH LOCALIZED SERVICE
- BROADEST PD PUMP OFFERING IN THE INDUSTRY
- COMPLETE PARTNER FOR YOUR HYGIENIC PROCESS



Around the world, Wright Flow Technologies provides solutions for challenges in fluid handling. You can count on the reliability of Wright Flow hygienic positive displacement (PD) pumps. Matching the right pump with your fluid processing needs is easy with innovative, robust designs, cleanability & an extensive product offering.

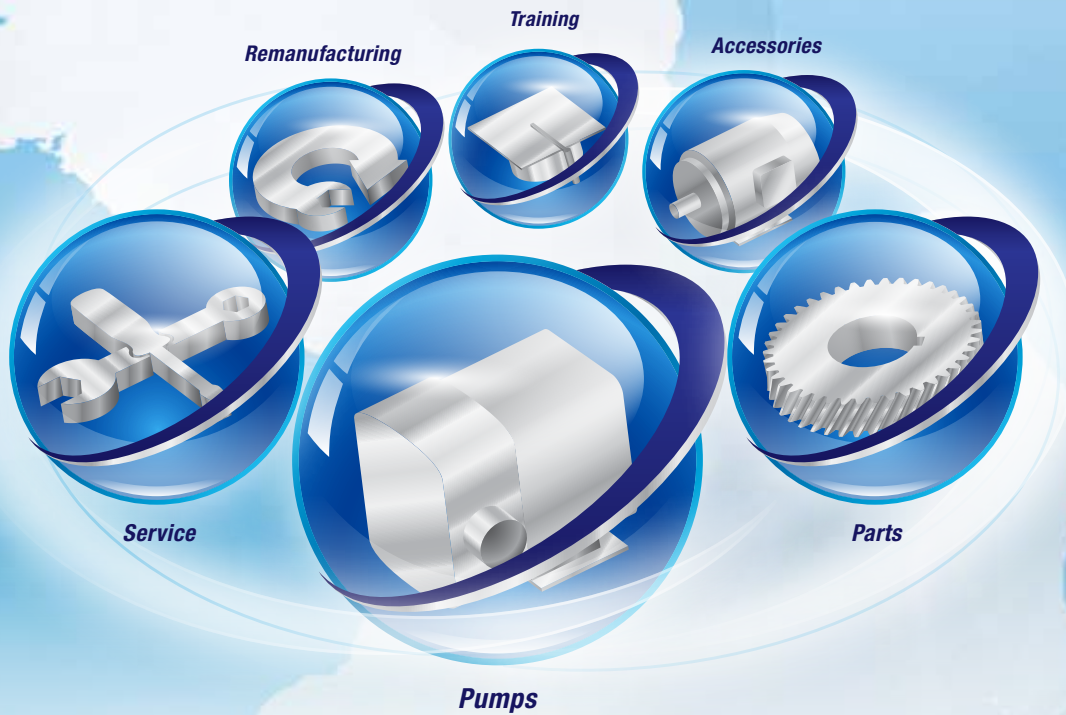

CHEMICAL

Raw Ingredients, Chemical Transfer, Solvent Recovery



PERSONAL CARE

Skin Care Products, Toothpastes, Cosmetics, Shower & Shaving Liquids, Hair Care Products



BEVERAGES

Distillers & Vinters, Fruit & Vegetable Purees, Carbonated Drinks, Juices

TRA10 SERIES

Designed for easy strip cleaning, the TRA10 series is the ideal choice for COP processing environments. The pump casing is independently fastened to the gearbox to prevent damage to the seals when the cover is removed & to allow the rotors to be turned while spraying down the fluid chamber.



How it Works

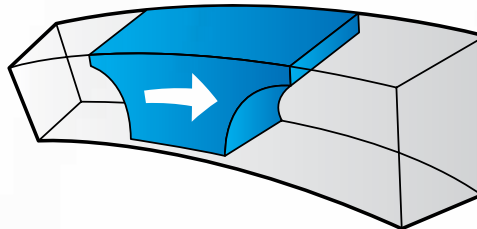

The deep channels in which the rotors travel provide large voids to minimize shear and bruising of solids.

Suction

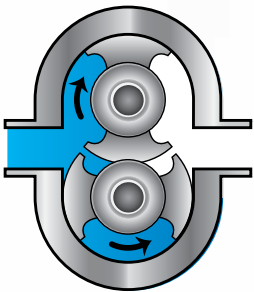

Wright Flow Technologies' rotor wings (pistons) rotate around the circumference of the channel in the pump casing. This continuously generates a partial vacuum at the suction port as the rotors unmesh, causing fluid to enter the pump.

Discharge

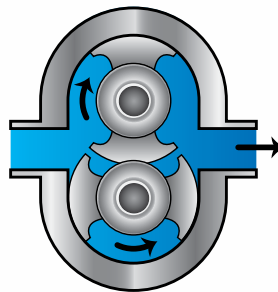

The fluid is transported around the channel by the rotor wings & is displaced as the rotor wings re-mesh, generating pressure at the discharge port. Pump output is directly proportional to speed & direction of flow is reversible.



FOOD

Baby Food, Edible Oils, Soft Fruits & Vegetables, Soups & Sauces, Egg, Fish, Meat, Poultry, Whey Proteins, Confectionary



DAIRY

Butter, Cheese, Cream, Milk, Yogurt, Yogurt Fruits



PHARMACEUTICAL

Medicinal Chemicals, Creams & Ointments, Syrups, Injectables, Ultra Filtration, Blood & Plasma Processing



TRA10 SERIES

CLEANABILITY

- Easy disassembly for easy COP (Clean Out of Place)
- Designed to 3A standards

PERFORMANCE

- Efficient handling for low & high viscosity applications
- Exclusive, non-galling WFT 808® alloy rotors standard; permits running at tighter clearances
- High strength 17-4 PH single piece shaft standard on 0300 and larger
- Helical gears, improving load carrying capabilities

EASE OF MAINTENANCE

- Drop-in-place with TRA20 & comparable manufacturer models
- Interchangeable service parts with comparable manufacturer models
- Easy disassembly





Remanufacture & Save!

SIGNIFICANT SAVINGS COMPARED TO PURCHASING NEW

WHY REMANUFACTURE?

- Worn pump is returned to **like-new condition & performance**
- Your remanufactured pump carries a **full 1 year factory warranty**
- All remanufactured pumps are **tested & certified**
- **Save big** compared to purchasing an entirely new pump
- Pumps can be remanufactured **up to four times**, depending on model & wear



WHAT YOU GET:

NEW *ROTORS*

NEW *BEARINGS*

NEW *SEAL COMPONENTS*

NEW *SHAFTS*

NEW *GEARS*



PORTING:

- Complete range of hygienic clamp, screw, flange & industrial screw connections
- Tri-clamp, flanged, DIN, IMDA, NPT, BSP, etc.

Hygienic Clamp

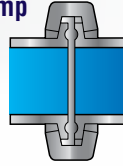

Bevel Seat (ACME)

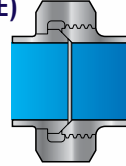

SEALS:

- Single O-ring
- Double O-ring w/ flush
- Complete range of material options
- Single mechanical
- Double mechanical w/ flush

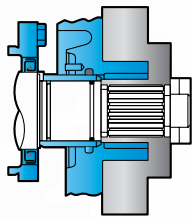

Single O-Ring Seals

- Standard O-rings and Cover Seals: Buna/FDA
- Optional O-rings and Cover Seals: FKM, EPDM, Silicone

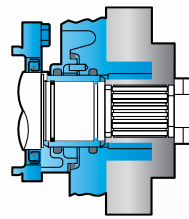

Double O-Ring Seals with Flush

- Standard O-rings and Cover Seals: Buna/FDA
- Optional O-rings and Cover Seals: FKM, EPDM, Silicone

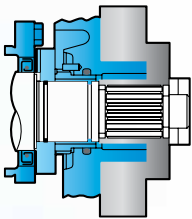

Single Mechanical Seals

- Standard Seal Faces: SiC/SiC
- Standard O-rings and Cover Seals: Buna/FDA
- Optional Faces: Carbon, Ceramic or Chrome Oxide
- Optional O-rings and Cover Seals: FKM, EPDM, Silicone

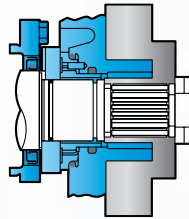

Double Mechanical Seals with Flush

- Standard Seal Faces: SiC/SiC/C
- Standard O-rings and Cover Seals: Buna/FDA
- Optional Faces: Carbon, Ceramic or Chrome Oxide
- Optional O-rings and Cover Seals: FKM, EPDM, Silicone

GEAR BOX:

- Powder-coated standard
- 304 stainless steel optional

ROTOR & CASING OPTIONS:

- 316 stainless steel pump casing standard w/ interior finished to 3-A standards
- Non-galling WFT 808® nickel alloy rotors standard or 316 stainless steel rotors optional
- Optional clearances: front face, hot, high temperature/high viscosity (chocolate)

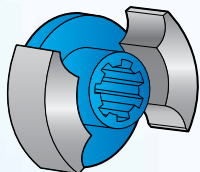

Twin Wing Rotors Standard

- Suitable for all liquids, provides minimum pulsation

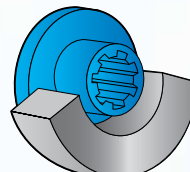

Single Wing Rotors Optional

- Standard Provides reduced shear on shear sensitive fluids or large solids such as fruit pieces, nut kernels, cheese curds or meats

MOUNTING:

- A gear case that can be mounted in any of four positions allows for horizontal or vertical porting, flexibility in drive shaft positioning to match reducer or gear motor input & improved access to grease fittings

PERFORMANCE RANGE:



COMPLIANT WITH THE FOLLOWING STANDARDS



TRA10 Model	Displacement		Max Pressure		Max Speed	Standard Ports		Max Capacity		Max Temperature	
	l/rev.	USG/rev.	BAR	PSI	RPM	mm	in.	m³/hr	USGPM	Deg. C	Deg. F
0060	0.03	0.008	14	200	800	38	1.5	1.3	6	150	300
0150	0.052	0.014	14	200	700	38	1.5	2	9	150	300
0180	0.11	0.03	14	200	600	38	1.5	3.8	17	150	300
0300	0.23	0.06	14	200	600	38	1.5	8.2	36	150	300
0450	0.38	0.1	27	400	600	51	2	13.3	59	150	300
0600	0.58	0.15	14	200	600	64	2.5	20.4	90	150	300
1300	0.96	0.25	14	200	600	76	3	34.1	150	150	300
2200	1.98	0.52	14	200	600	102	4	70.4	310	150	300
3200	2.85	0.75	14	200	600	152	6	102	450	150	300

TRA10 Rectangular Flange Model	Displacement		Max Pressure		Max Speed	Inlet (WxL)		Outlet		Max Capacity		Max Temperature	
	l/rev.	USG/rev.	BAR	PSI	RPM	mm	in.	mm	in.	m³/hr	USGPM	Deg. C	Deg. F
0240	0.11	0.03	14	200	400	33.27 x 125.22	1.31 x 4.93	38.1	1.5	2.5	11	150	300
0340	0.22	0.06	14	200	400	44.50 x 171.45	1.75 x 6.75	50.8	2	5.4	24	150	300
0640	0.57	0.15	14	200	400	56.90 x 224.03	2.24 x 8.82	57.2	2.5	13.6	60	150	300
1340	0.96	0.25	14	200	400	75.44 x 234.95	2.97 x 9.25	76.2	3	22.7	100	150	300
2240	1.97	0.52	14	200	400	98.30 x 279.40	3.87 x 11.00	101.6	4	45.4	200	150	300

Note: Hot clearances required for high temperature operation.

Preventive Maintenance Kits

ENSURE TROUBLE-FREE OPERATION & SUPERIOR PERFORMANCE



BENEFITS OF MAINTENANCE KITS:

- Everything you need in one place
- Reduce frequency of repairs
- Increase service life
- Increase uptime
- Save time & money
- Kits include exploded diagram & parts list



REBUILD VS. REPLACE:

- Wright Flow kits are designed to save time & money, making preventive maintenance & rebuilding easier & more cost-effective
- Wright Flow pumps are designed & built to the highest standards, for long life & to be rebuilt instead of replaced when applicable
- Tool kits also available

BACK OF MAINTENANCE KIT:

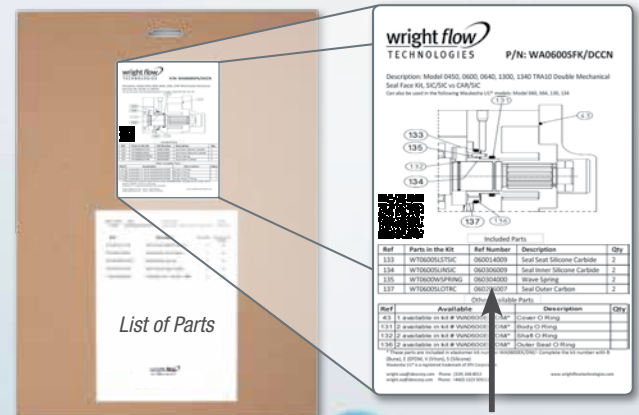

List of Parts

Part Number Cross-Reference



FOR MORE INFORMATION, CONTACT YOUR LOCAL AUTHORIZED WRIGHT FLOW TECHNOLOGIES DISTRIBUTOR OR CONTACT US AT:

WRIGHT FLOW TECHNOLOGIES, INC.
406 State Street
Cedar Falls, IA 50613 USA
Phone: (319) 268-8013 • E-mail: wright.usa@idexcorp.com

WRIGHT FLOW TECHNOLOGIES LTD.
Highfield Industrial Estate, Edison Road Eastbourne
East Sussex, United Kingdom, BN23 6PT
Phone: +44(0) 1323 509211 • E-mail: wright.eu@idexcorp.com

WRIGHT FLOW TECHNOLOGIES SUZHOU
Block 6, No.428 Xing Long Street
Su Chun Industrial Square, Suzhou Industrial Park
Suzhou 215126, China
Phone: (0512) 62833000*333

Distributed By:

WRIGHTFLOWTECHNOLOGIES.COM

